

# CONTENTS

---

<b>Safety Information</b> .....	1
<b>I. SPECIFICATIONS</b> .....	1
1.General Information.....	1
2.Electrical Specifications.....	2
<b>II. SYMBOL DEFINITION &amp; BUTTON LOCATION</b> .....	4
1.Name of Parts and Position.....	4
2.LCD Display.....	5
3.Button Operation.....	5
<b>III. OPERATION INSTRUCTION</b> .....	7
1.DC Voltage Measurements.....	7
2.AC Voltage Measurements.....	7
3.AC/DC Current Measurements.....	8
4.Diode Tests.....	8
5.Continuity Measurements.....	9
6.Resistance Measurements.....	9
7.Capacitance Measurements.....	10
8.Frequency & RPM Measurements.....	10
9.Temperature Measurements.....	11
<b>IV. MAINTENANCE</b> .....	11
<b>V. BATTERY &amp; FUSE REPLACEMENT</b> .....	12
<b>VI. SETUP TestLink</b> .....	13

## Read First: Safety Information

- Never use the meter if the meter or test leads look damaged.
- Be sure the test lead and switch are in the correct position for the desired measurement.
- Never measure resistance or testing acoustic continuity in a circuit when power is applied.
- Never connect the probe to a voltage source when the test leads are plugged into the uA/mA and 10A input jack.
- Never apply more than rated voltage between any input jack and earth ground.
- Be careful when working with voltages above 60V dc or 30V ac rms. Such voltages pose a shock hazard.
- Keep your fingers behind the finger guards on the test probes when making measurements.
- To avoid false readings, replace the battery immediately, when  symbol appears.
- In order to protect the tester, the testing should not last longer than 30 second when the measuring current is greater than 10A and between each measuring there should be at least 2 min to cool down.

## Symbols



**Safety Information, Refer to the manual.**



**Dangerous Voltage May Be Present.**



**Meter is protected throughout by double insulation or reinforced insulation.**

When servicing, use only specified replacement parts.



**Comply with IEC1010-1 1000V CATIII**

## I. SPECIFICATIONS

### 1. General information

Environment conditions:

- Installation Categories III
- Pollution Degree 2
- Altitude up to 2000 meters
- Indoor use only
- Relatively humidity: 80%RH max.
- Operation Ambient temp: 0~40°C

Maintenance & Clearing:

Repairs or servicing not covered in this manual should only by qualified personal.  
Periodically wipe the case with a dry cloth and detergent. Do not use abrasives or solvents on this instruments.

Display:

Digital: 4000 counts

Analog: 41 segments

Sampling Rate:

Digital: 2 times/sec

Analog: 20 times/sec for Bargraph indication.

Over Range Indication: LCD will show "OL"

Low battery Indication:

The  is displayed when the battery voltage drop below the proper operation range.

Battery type: 9V, NEDA1604 or IEC6F22 or JIS006P

Battery Life: 100hrs typical (alkaline Battery)

Polarity: "  " indicates negative input.

Auto Power Off Time: 30 minutes

Dtalogger: 32,000 Record

Operating Temperature and Humidity:  
 0°C to 40°C (32°F to 140°F) below 80%RH  
 Storage Temperature and Humidity:  
 -10°C to 60°C (14°F to 140°F) below 70%RH  
 Electromagnetic Compatibility:  
 Vac and Aac only: RF field = 3V/m  
 Total accuracy = specified accuracy + 2.0% of range  
 Safety: 1000V CAT III Regulation EN61010: Part 1: 1993  
 Certification: **CE**

Dimensions (L x W x H):  
 Meter: 198 x 86 x 38mm (7.8" x 3.4" x 1.5")  
 With holster: 209 x 94 x 48mm (8.2" x 3.7" x 1.9")  
 Weight: Approx. 430g (15.2 oz)  
 With holster: Approx. 600g (21.3oz)

Accessories:  
 Test leads, Battery, Instruction manual, Temperature Converter, K type bead  
 Temperature probe, Holster, RS-232 Cable, Software.

## 2. Electrical Specifications

### Accuracy specification:

$\pm$ [...%of reading]+[...number of least significant digits ] at 18°C to 28°C (64°F to 82°F)  
 $\leq$ 80%RH

True RMS for ACV and ACA, accuracy are specified from 5% to 100% of range,  
 accuracy add ((1.0%rdg) for crest factor 1.4<C.F<3 at full scale & CF<6 at half scale.

### DC Voltage(Auto Range)

Range	Resolution	Accuracy	Input Impedance	Overload protection
400mV	0.1mV	0.3%+2	$\approx$ 100M $\Omega$	1200V <sub>peak</sub>
4V	1mV	0.3%+2	10M $\Omega$	1200V <sub>peak</sub>
40V	10mV	0.3%+2	10M $\Omega$	1200V <sub>peak</sub>
400V	100mV	0.3%+2	10M $\Omega$	1200V <sub>peak</sub>
1000V	1V	0.5%+2	10M $\Omega$	1200V <sub>peak</sub>

### AC Voltage(Auto Range)

Range	Resolution	Accuracy		Input Impedance	Overload protection
		45Hz-500Hz	500Hz-1KHz		
400mV	0.1mV			$\approx$ 100M $\Omega$	1200V <sub>peak</sub>
4V	1mV	0.5%+5	1%+5	10M $\Omega$	1200V <sub>peak</sub>
40V	10mV	0.5%+5	1%+5	10M $\Omega$	1200V <sub>peak</sub>
400V	100mV	0.5%+5	1%+5	10M $\Omega$	1200V <sub>peak</sub>
750V	1V	0.8%+5	1.2%+5	10M $\Omega$	1200V <sub>peak</sub>

### Diode Tester

Range	Resolution	Accuracy	Test Current	Test Voltage	Overload protection
	1mV	1%+2	<1mA	<3.5V	600Vrms

### Continuity beeper

Range	Active Range	Test Voltage	Overload protection
	under40 $\Omega$	<-1.5V	600Vrms

**DC Current( $\mu$ A, mA, Auto Range)**

Range	Resolution	Accuracy	Burden Voltage	Overload protection
400 $\mu$ A	0.1 $\mu$ A	0.8%+2	< 0.25Vrms	0.5A/600V Fast Blow Fuse
4000 $\mu$ A	1 $\mu$ A	0.8%+2	< 1Vrms	0.5A/600V Fast Blow Fuse
40mA	10 $\mu$ A	0.8%+2	< 0.25Vrms	0.5A/600V Fast Blow Fuse
400mA	100 $\mu$ A	0.8%+2	< 1.5Vrms	0.5A/600V Fast Blow Fuse
20A	10mA	1.0%+2	< 1Vrms	15A/600V Fast Blow Fuse

**AC Current( $\mu$ A, mA, Auto Range)**

Range	Resolution	Accuracy		Burden Voltage	Overload protection
		45Hz~500Hz	500Hz~1KHz		
400 $\mu$ A	0.1 $\mu$ A	1.3%+5	1.6%+5	< 0.25Vrms	0.5A/600V Fast Blow Fuse
4000 $\mu$ A	1 $\mu$ A	1.3%+5	1.6%+5	< 1Vrms	0.5A/600V Fast Blow Fuse
40mA	10 $\mu$ A	1.3%+5	1.6%+5	< 0.25Vrms	0.5A/600V Fast Blow Fuse
400mA	100 $\mu$ A	1.3%+5	1.6%+5	< 1.5Vrms	0.5A/600V Fast Blow Fuse
20A	10mA	1.5%+5	1.8%+5	< 1Vrms	15A/600V Fast Blow Fuse

**Ohms(Auto Range)**

Range	Resolution	Accuracy	Test Voltage	Overload protection
400 $\Omega$	0.1 $\Omega$	0.6%+2	< 1.5V <sub>b c</sub>	600Vrms
4K $\Omega$	1 $\Omega$	0.6%+2	< 1.5V <sub>b c</sub>	600Vrms
40K $\Omega$	10 $\Omega$	0.6%+2	< 1.5V <sub>b c</sub>	600Vrms
400K $\Omega$	100 $\Omega$	0.6%+2	< 1.5V <sub>b c</sub>	600Vrms
4M $\Omega$	1K $\Omega$	0.6%+2	< 1.5V <sub>b c</sub>	600Vrms
40M $\Omega$	10K $\Omega$	1%+3	< 1.5V <sub>b c</sub>	600Vrms

**Frequency(Auto Range)**

Range	Resolution	Accuracy	Sensitivity	Overload protection
4KHz	1Hz	0.05%+1	< 1Vrms	600Vrms
40KHz	10Hz	0.05%+1	< 1Vrms	600Vrms
400KHz	100Hz	0.05%+1	< 1Vrms	600Vrms
4MHz	1KHz	0.05%+1	< 3Vrms	600Vrms
40MHz	10KHz	0.05%+1	< 10Vrms	600Vrms

**Temperature( $^{\circ}$ C/ $^{\circ}$ F)**

Range	Resolution	Accuracy	Overload protection
$^{\circ}$ C	1 $^{\circ}$	0 $^{\circ}$ C~1000 $^{\circ}$ C:(1%+3d gts)	600Vrms
		-50 $^{\circ}$ C~0 $^{\circ}$ C:(1%+4d gts)	
$^{\circ}$ F	1 $^{\circ}$	32 $^{\circ}$ F~1832 $^{\circ}$ F:(1%+6d gts)	600Vrms
		-58 $^{\circ}$ F~32 $^{\circ}$ F:(1%+8d gts)	

**RPM(Auto Range)**

Range	Resolution	Accuracy	Sensitivity	Overload protection
40K RPM	0.01K RPM	0.05%rdg+1 dgt	< 1Vrms	600Vrms
400K RPM	0.1K RPM	0.05%rdg+1 dgt	< 1Vrms	600Vrms
4M RPM	1K RPM	0.05%rdg+1 dgt	< 1Vrms	600Vrms
40M RPM	10K RPM	0.05%rdg+1 dgt	< 3Vrms	600Vrms
400M RPM	100K RPM	0.05%rdg+1 dgt	< 10Vrms	600Vrms

↔ Capacitance (Auto Range)

Range	Resolution	Accuracy	Overload protection
4nF	1PF	1.9%rdg+20dgts	600Vrms
40nF	10PF	1.5%rdg+10dgts	600Vrms
400nF	100PF	1.5%rdg+10dgts	600Vrms
4uF	1nF	1.5%rdg+10dgts	600Vrms
40uF	10nF	1.9%rdg+10dgts	600Vrms
400uF	100nF	1.9%rdg+10dgts	600Vrms
4mF	1uF	1.9%rdg+10dgts	600Vrms
40mF	10uF	3%rdg+10dgts	600Vrms

## II. SYMBOL DEFINITION & BUTTON LOCATION

### 1. Name of Parts and Position

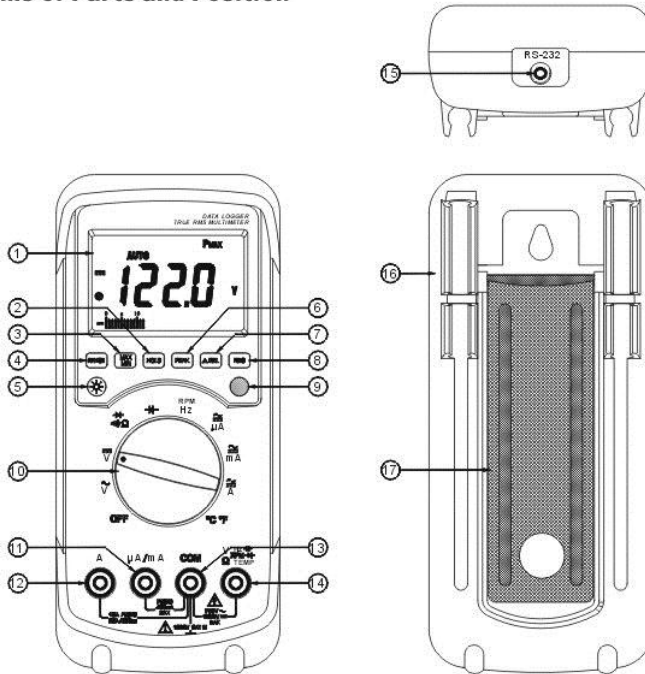

- |                          |                         |                               |
|--------------------------|-------------------------|-------------------------------|
| ① LCD Display            | ⑦ Relative Button       | ⑬ "COM" Terminal              |
| ② Hold Button            | ⑧ Record Button         | ⑭ "VΩ↔HzTemp↔" Terminal       |
| ③ Maximum Minimum Button | ⑨ Shift Function Button | ⑮ "RS-232" Interface Terminal |
| ④ Range Button           | ⑩ Function Select Dial  | ⑯ Holster                     |
| ⑤ Back-light Button      | ⑪ "uA/mA" Terminal      | ⑰ Tilt Stand                  |
| ⑥ Peak Hold Button       | ⑫ "Amp." Terminal       |                               |

## 2. LCD Display

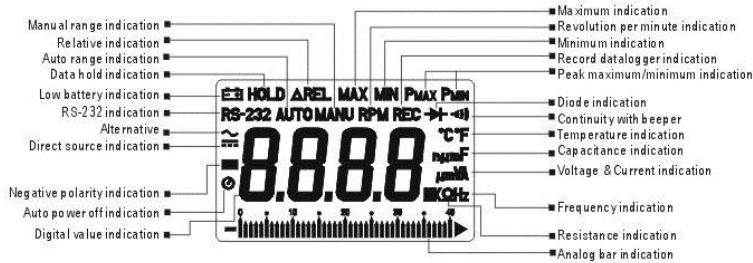

## 3. Button Operation

### ■ Relative Button

Press button to enter the relative mode. The display is zeroed, and the reading is stored as reference value for subsequent measurements. Press it again, the "ΔREL" annunciator blinking and stored relative value will display. Press and hold down button for 1 second to exit the relative mode.

### ■ Auto-range & Manual Range Button:

- \* Press to select the Manual Range mode and the "MANU" annunciator turn on and the meter remains in the same range it was.
- \* In the Manual Range mode, each time you press button, the range (and the input range annunciate) increases, and a new value is display.
- \* If the meter is in the highest range, the next range is change to the lowest range. To exit the Manual Range mode and return to Auto Range mode. Press and hold down for 1 seconds, the "AUTO" annunciate turns back on.

### ■ MAX/MIN recording button:

Press button to enter the maximum and minimum recording mode, select the proper range before using MAX/MIN to ensure that reading value will not exceed the measurement range. Press the button once to select MAX value. Press it again to select MIN value, and press again to select current value with "MAX.MIN" annunciator blinking. Press and hold down button for 1 second to exit the MAX MIN mode.



### ■ AC/DC Current Select and $\Omega/\Omega/\rightarrow$ Select and $^{\circ}\text{C}/^{\circ}\text{F}$ Select and Hz/RPM Select Button:

- \*To select function AC or DC in current ampere range.
- \*To select continuity measurements or Resistance or Diode measurement at  $\Omega/\Omega/\rightarrow$  range.
- \*To select temperature  $^{\circ}\text{C}$  or  $^{\circ}\text{F}$  measurement.
- \*To select function frequency(Hz) or RPM measurement.

### ■ Back-light Button:

When one press the button, the meter will turn on back-light will also be turn on back-light, press the button again will turn off back-light. The back-light will also be turned off automatically after 30 seconds to extend battery life.

- **Record Datalogger  Button:**

When one press the "" button, the meter will star recording. The "REC" and "RS-232" annunciator are display, press the "" button again will stop recording. If you want to clear the memory, power off the meter, then release button, LCD "REL" annunciator will blinking then to clear the memory.



- ** Data Hold Button:**

At any time, the user can hold then press the "" button and release the held data by press it again.

- ** Peak Hold Function Button:**

This meter is built with 1ms peak hold function at ACA, ACV and DCV, DCA range. Before the user wants to perform a peak hold operation, he must finish calibration process at first.

To invoke the calibration operation, the user must press and hold the "" button for 2 second. After that "CAL" will display on the LCD and the offset will be calculated and kept in the meter.

After the calibration the user can choose Pmax or Pmin by press "" button to keep the peak reading. Press the "" button for 2 seconds will return the meter back to normal operation.

Once the function range is change, the meter will need another calibration for peak measurement.

- **Function Selector Switch:**

For power OFF and selection of desired function range.

- **COM Measuring Connector:**

To connect negative lead (black test lead) for all function measurement.

- **20A Measuring Connector:**



To connect positive lead (red test lead) for current measurement below 10A continuous; 20A for 30 seconds maximum

- **V $\Omega$ , Hz,  $\rightarrow$ ,  $\rightarrow$ , RPM, TEMP Measuring Connector:**

To connect positive lead (red test lead) for voltage, Diode, Frequency, RPM, Capacitance, Temperature, Resistance and Continuity measurement.

- **Auto Power Off:**

The meter shuts automatically after 30 minutes if no operations are performed.

To disable automatic power-off feature, press the "" button and keep it press up the meter and the  annunciator will not show up.

- **Tilt stand**

- **RS-232 Interface:**

The RS-232 signal output is a 9600 bps N81 serial interface.

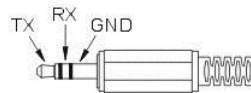

### III. Operation Instruction

#### 1. DC Voltage Measurements:

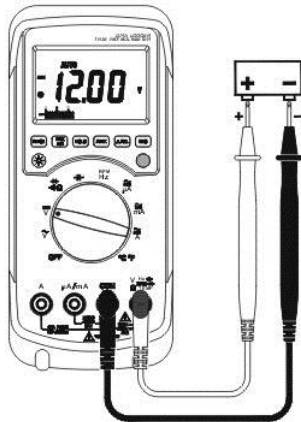

#### ⚠ WARNING

Maximum Input Voltage is 1000VDC, 750VAC. Do not attempt to take any voltage measurement that may exceed to avoid electrical shock hazard an/or damage to this instrument.

1. Connect red test lead to "V" jack and black test lead to "COM" jack.
2. Set range switch to  $V_{\text{—}}$  range.
3. Connect the test leads in parallel to the circuit being measured.
4. Read the Voltage value on LCD.

#### 2. AC Voltage Measurements:

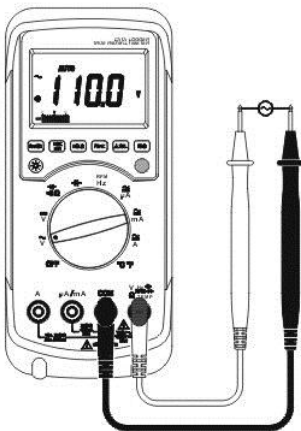

#### ⚠ WARNING

Maximum Input Voltage is 1000VDC, 750VAC. Do not attempt to take any voltage measurement that may exceed to avoid electrical shock hazard an/or damage to this instrument.

1. Connect red test lead to "V" jack and black test lead to "COM" jack.
2. Set range switch to  $V_{\sim}$  range.
3. Connect the test leads in parallel to the circuit being measured.
4. Read the Voltage value on LCD.

### 3. AC/DC Current Measurements:

**⚠ WARNING**

To avoid injury, do not attempt a current measurement if the open circuit voltage exceeds the rated voltage of the meter.

1. Connect red test lead to the "mA/ uA" jack for current measurements up to 400mA. (for measuring current between 400mA to 20A , connect red test lead to "A" jack) connect black test lead to " COM " jack.
2. Set range selector switch to desired A range and press DC/AC button to select AC/DC function.
3. Cut the power to the circuit to be tested and connect the instrument in series with the circuit with the black test lead on the negative " - " side and the red lead on the positive " + " side being measured.
4. Apply power and read the ampere value on LCD.

**Note:**

To avoid blowing an input fuse, use the 10 A jack until you are sure that the current is less than 400 mA. When Doing Current Measurement.

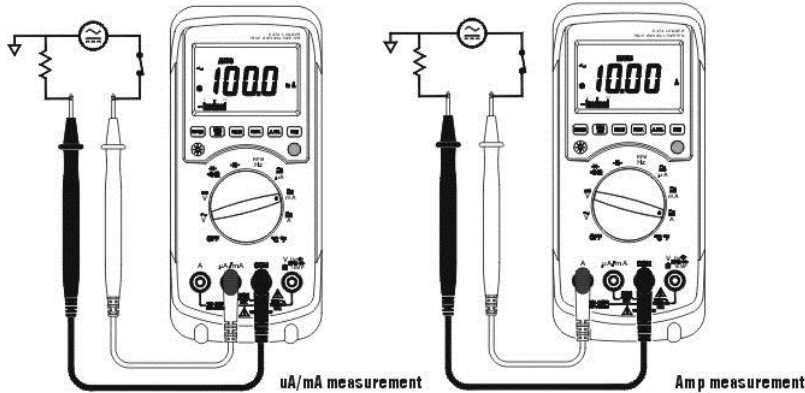

### 4. Diode Tests

**⚠ WARNING**

Before taking any in-circuit measurement ,remove power from the circuit being tested and discharge all capacitors in the circuit.

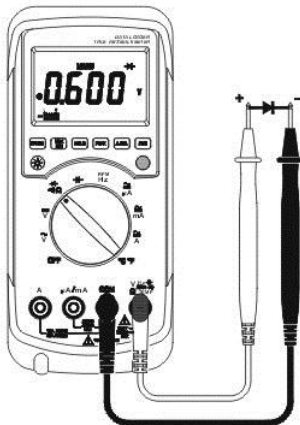

1. Connect red test lead to "  $\rightarrow$  " jack and black test lead to "COM " jack.
2. Set range selector Switch to "  $\rightarrow$  " range.
3. Connect the red test lead to the anode side and black test lead to the cathode side of the diode being tested.
4. Read forward Voltage(  $V_f$  ) value on LCD.
5. If the polarity of test leads are reversed with diode polarity, the digital reading show " OL ". This can be used for distinguishing anode and cathode terminal of a diode.

## 5. Continuity Measurements:

### ⚠ WARNING

Before taking any in-circuit measurement, remove power from the circuit being tested and discharge all capacitors in the circuit.

1. Connect red test lead to " $\Omega$ " jack and black test lead to "COM" jack.
2. Set Range Switch to " $\rightarrow$ " range.
3. Connect test lead to the circuit being measured.
4. When the impedance between the test jack is lower than  $40\Omega$ , it will activate a continuous beeper.

**Note:** Continuity Test is available to check open/short of the circuit.

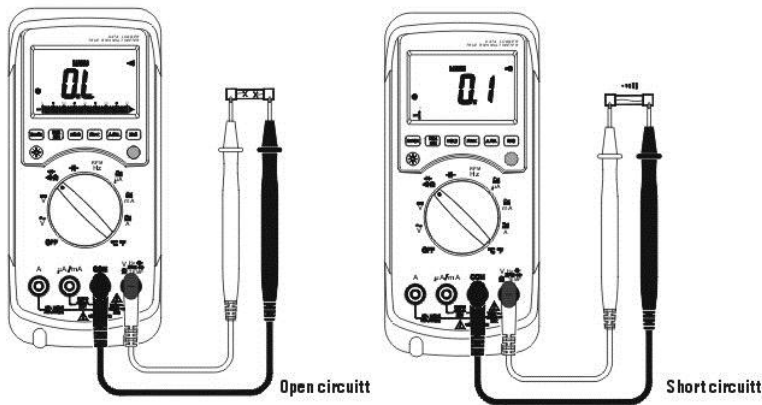

## 6. Resistance Measurements:

### ⚠ WARNING

Before taking any in-circuit measurement, remove power from the circuit being tested and discharge all capacitors in the circuit.

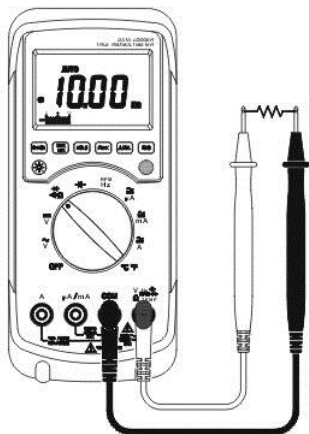

1. Connect red test lead to " $\Omega$ " jack and black test lead to "COM" jack.
2. Set Range Switch to " $\Omega$ " function.
3. Connect test lead to the circuit being measured and read the resistance value on LCD.

## 7. Capacitance Measurements:

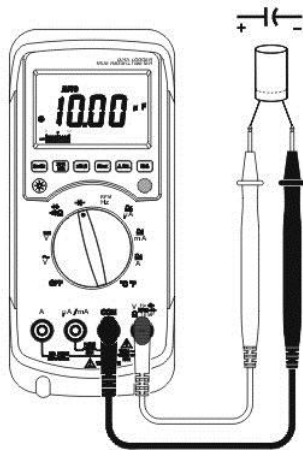

### ⚠ WARNING

To avoid damage to the meter, disconnect circuit power and discharge all capacitors before measuring capacitance. Use the DC voltage function to confirm that the capacitor is discharged.

1. Connect red test lead to "+C" jack and black test lead to "COM" jack.
2. Set range switch to "C" function.
3. Connect tips of the test leads to the capacitor being tested.
4. Read the capacitance value on LCD.

### Note:

- a. The bar graph is disable in capacitance measurement mode. However, at 4mF and 40mF range, the bar graph is used to display the time rest to accomplish the measurement.
- b. In order to obtain an accurate reading, a capacitor must be discharged before measurement begins. The meter has an automatically discharge the capacitor. In discharge mode, the LCD display "DISC", but discharging through the meter is quite slow. We recommend the user to discharge the capacitor with some other apparatus.

## 8. Frequency & RPM Measurements:

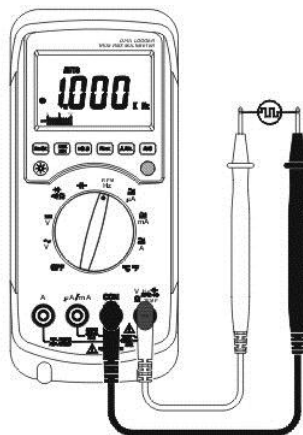

1. Connect red test lead to "Hz" jack and black test lead to "COM" jack.
2. Set Range Switch to "Hz" or RPM range by pressing button.
3. Connect the test lead in parallel to the circuit being measured.
4. Read the frequency or RPM value on LCD.

## 9. Temperature Measurements

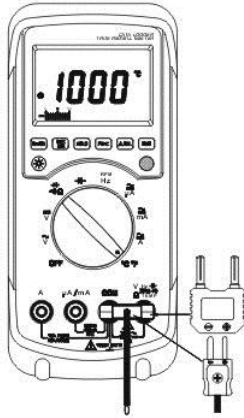

1. Set range switch to °C/°F function.
2. Insert the banana plug K-type temperature bead probe with correct "+" "-" polarities.
3. Press blue key to select desired °C or °F unit.
4. Read to temperature value on LCD.

## IV. MAINTENANCE

### ⚠ WARNING

To avoid electric shock, remove the test leads before opening the case, and close the case before using the meter.

To prevent fire and possible arc-flash, use fuses with ratings shown on the back of the meter.

### ⚠ CAUTION

To avoid contamination or static damage, do not touch the circuit board without proper static protection.

## V. BATTERY & FUSE REPLACEMENT

### ⚠ WARNING

To prevent electrical hazard or shock , turn off multimeter and disconnect test leads before removing back cover.

- 1.Set range switch to " OFF " position .Use a screwdriver to remove the 5 screws as show in Fig 1.
- 2.Place the front panel face up.
- 3.Take out the battery and replace them with one new battery type 1604A 9V is required.
- 4.Place back the front cover and secure it with the original screw.

### ⚠ WARNING

For safety, use exact replacement .

Fuse 1 : F0.5A / 600V 10  $\phi$   $\times$  38 mm Fast blow type

Fuse 2 : F15A / 600V 10  $\phi$   $\times$  38 mm Fast blow type

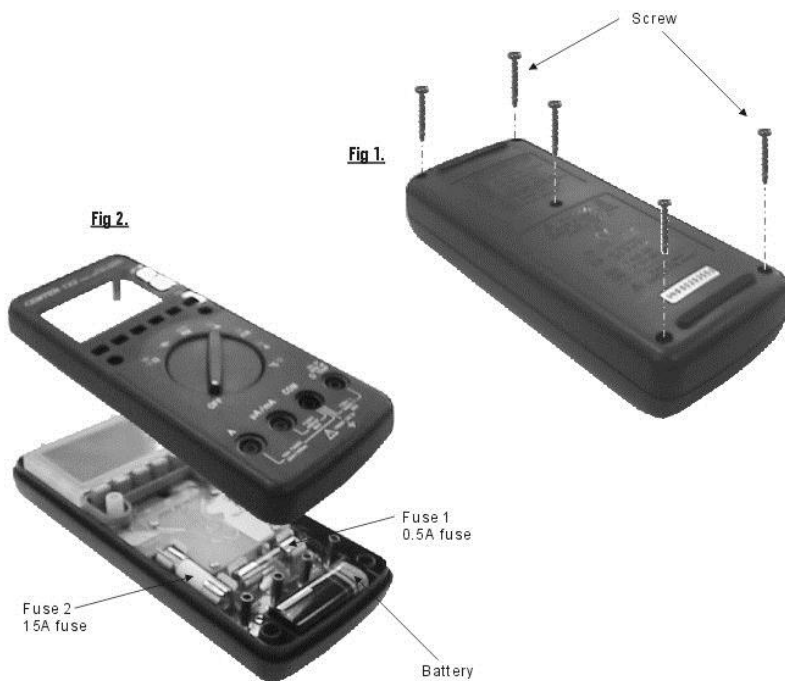

## VI. Setup TestLink (Multimeter)—RS232 interface software:

### ■ The TestLink package contains:

1. Two 3.5" diskettes
2. Custom designed RS232 cable for TestLink.

### ■ System Required:

Windows 95 or Windows 98 or Windows NT 4.0.

### ■ Minimum Hardware Required:

486-100 MHz PC compatible , or above 16 MB RAM ;  
At least 5 MB hard disk space available to install TestLink program. Recommended display resolution is 800X600 or above.

### ■ Install TestLink:

1. We recommend closing all other application before installing TestLink.
2. Insert setup diskette 1 to floppy disk drive A.
3. Choose the Start button on the Taskbar and select Run.
4. Type A:\SETUP and choose OK, then it will copy SE120.exe ( executable file ) and help file to your hard disk ( default is c:\program files\TestLink\SE120 ).

### 1.Run TestLink

Select TestLink | SE120 form "STAR" menu of Windows, figure 6.1 will show

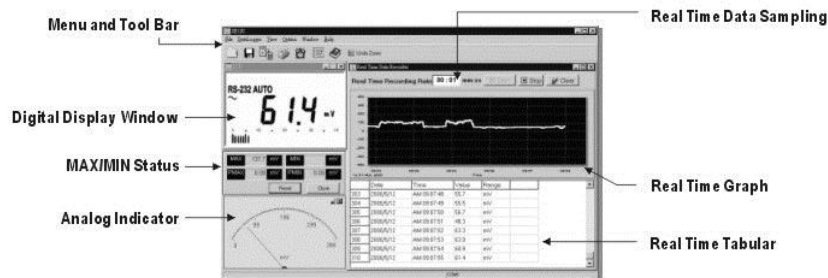



Figure 6-1

### 2.Real Time Tabular and Real Time Graph.

Select Run from menu or press  from the tool bar of Real Time Graph window to begin real time data collection from multimeter.

You can change the data interval by editing the sampling rate box on the right hand side of Real Time Graph window (see figure 6-1).

### 3. DataLogger

Select DataLogger from menu to load recorded data for multimeter. There will be a progress bar showing how many bytes should be loaded and how many bytes have been received. When data is loaded successfully, there will be a Datalogger window show up. (See figure 6-2)

Data Sets- Display how many data sets were loaded and the detail information for each data set (start date, start time, recording rate and data length), and you can click at any data set to choose the set for graph and tabular.

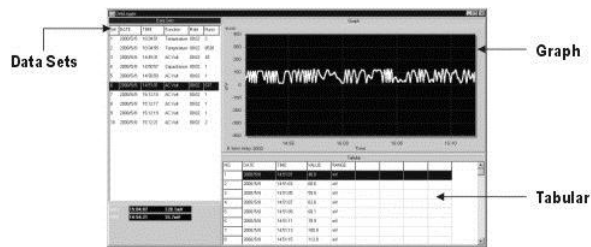

Figure 6-2

**4. For other operation instruction, please refer to the on-line help while executing TestLink.**